

Contents

Safety Information	3
Product Inspection	4
Radio Overview	6
Battery Information	10
Antenna Information	13
Assembly and Disassembly	13
General Radio Operations	20
Programmable Auxiliary Functions	22
Functions and Settings	22
CTCSS/CDCSS	22
Battery Save	23
Power Adjust	23
Time-out Timer (TOT)	23
Battery Strength Indicator	23
Monitor / Squelch Off	24
Scan	25
Busy Channel Lockout (BCL)	27
Low Battery Alert	27
Voice Operated Transmit (VOX)	27
ATIS	28
HDC1200 PTT ID Encode	28
DOS (Data Operated Squelch)	28
2-Tone Decode	29
Troubleshooting	30
Care and Cleaning	31
Optional Accessory	32
Channel Frequency Table	36
CTCSS Table 38	36
CDCSS Table (83)	37
Glossary	39

Preface

Thank you for your purchase of the HYT TC-610/610P radio - the choice for professionals.

TC-610/610P is a professional radio that with exquisite and ergonomic design, which bring user a fine operation feel. The TC-610/610P is customized for noisy environments such as construction sites because all TC-610/610P radios are approved to dust & water protection Class IP66 and endowed with large speaker.

This easy-to-use radio will deliver you secure, instant and reliable communications at peak efficiency. Please read this manual carefully before use. The information presented herein will help you to derive maximum performance from your radio.

MODELS COVERED IN THIS MANUAL

TC-610/610P VHF Two-way Radio

TC-610/610P UHF Two-way Radio

Safety Information

The following general safety precautions as would normally apply, which should be observed during all phases of operation, service and repair of this equipment.

- ◇ Turn off your radio prior to entering any area with a potentially explosive atmosphere.
- ◇ Do not charge your battery in a potentially explosive atmosphere.
- ◇ Do not use any portable radio that has a damaged antenna. If a damaged antenna comes into contact with your skin, a minor burn can result.
- ◇ This equipment should be serviced by qualified technicians only.
- ◇ To avoid possible interference with blasting operations, turn off your radio when you are near electrical blasting caps. In a blasting area or in areas such as hospital site posted "Turn off two-way radio"; when taking an airplane, please obey the "turn off two-way radio" instruction of aircrew staff as well.
- ◇ For vehicles with an air bag, do not place a radio in the area over an air bag or in the air bag deployment area. Air bags inflate with great force. If a radio is placed in the air bag deployment area and the air bag inflates, the radio may be propelled with great force and cause serious injury to occupants of the vehicle.
- ◇ Do not expose the radio to direct sunlight over a long time, nor place it close to heating source.
- ◇ When using your radio, hold the radio in a vertical position with the microphone 3 to 4 centimeters away from your lips.
- ◇ If you wear a radio on your body when transmitting, ensure the radio and its antenna is at least 2.5cm away from your body.

Cautions!

1. Please attach the earpiece cover if there is not any earpiece in use. Consequences such as water and dust getting into interior parts of radio, or terminal getting rusty, due to irreparable damage, would lead to error even rejection of radio.

2. Do use the earpiece with good waterproof performance; meanwhile, make sure that the earpiece is perfectly attached to the earpiece jack.

3. For avoidance of serious damage due to water getting into the interior radio, do not destroy or tear down the label covered above the waterproof test hole.

4. In consideration of IP66 standard, user only can **WASH** the radio when cleaning; do **NOT IMMERSE** the radio into water for any clean.

In washing, please turn off the radio first; the clean time of it must be controlled within 2 to 3 minutes each time. If the radio accidentally drops into water, please take it out quickly, power it off and use it unless the parts are wiped or totally air dried.

5. For avoidance of affection of product life due to dust getting into interior radio, please use the carrying case.

Product Inspection

Before unpacking the TC-610/610P portable radio, please inspect the packaging for signs of damage and report any damage to your dealer.

Upon unpacking of the TC-610/610P portable radio, please ensure that all items shipped were received, report any missing or damaged items to your dealer.

Item	Qty. (PCS)
Antenna	1
Belt Clip	1
Strap	1
Battery	1
MCU Charger	1
Switching Power	1
Owner's Manual	1

Note: 1. Frequency band is marked on the label of antenna. Please refer to the label on the radio unit for detailed frequency band information.

2. The radio unit is shipped with screws mounted from the factory.

		
<p>Li-Ion Battery</p>	<p>MCU Rapid-rate Charger (for Li-ion/Ni-MH Batteries)</p>	<p>Switching Power (different P/N for different countries and areas)</p>
		
<p>Belt Clip</p>	<p>Strap</p>	<p>Antenna</p>

Radio Overview

TC-610

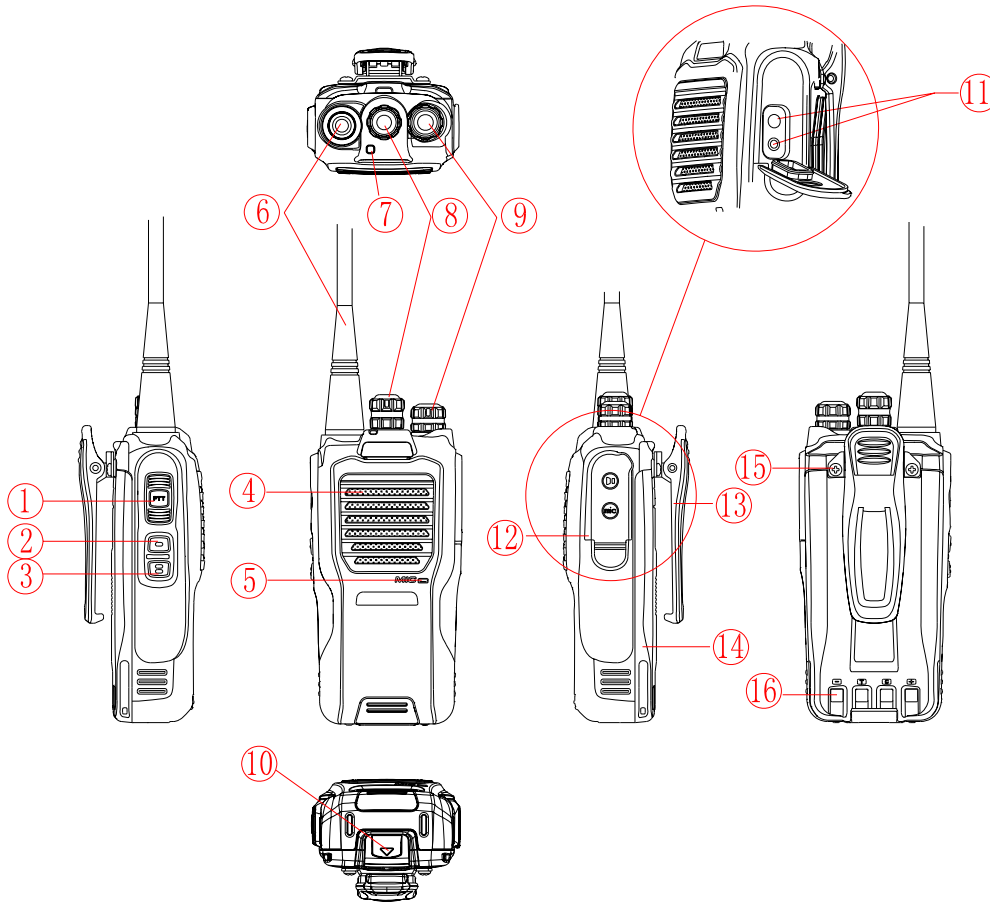

(1) PTT (Push-to-Talk) key	(2) SK1 key (Side Key 1) (programmable)	(3) SK2 (Side Key 2) (programmable)	(4) Speaker
(5) Microphone	(6) Antenna	(7) LED Indicator	(8) Channel Selector Knob
(9) Radio On-Off /Volume Control Knob	(10) Battery Latch	(11) Accessory Jack	(12) Accessory cover
(13) Belt Clip	(14) Battery	(15) Screw	(16) Electrode Piece

TC-610P

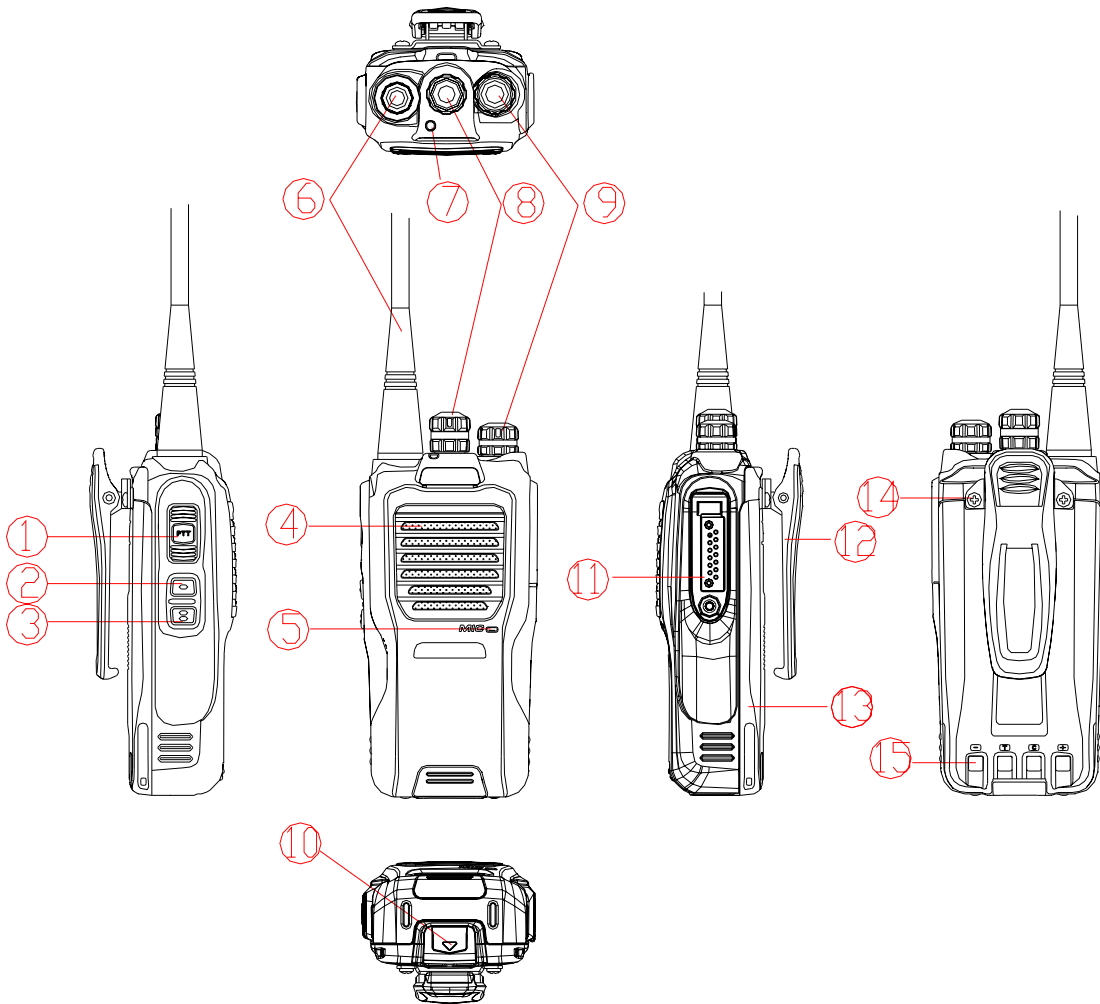

(1) PTT (Push-to-Talk) key	(2) SK1 key (Side Key 1) (programmable)	(3) SK2 (Side Key 2) (programmable)	(4) Speaker
(5) Microphone	(6) Antenna	(7) LED Indicator	(8) Channel Selector Knob
(9) Radio On-Off /Volume Control Knob	(10) Battery Latch	(11) Accessory Jack	(12) Belt Clip
(13) Battery	(14) Screw	(15) Electrode Piece	

* **PTT** (Push-to-Talk) Key

Press and hold down the **PTT** key to transmit, release it to receive.

***SK1** (Side Key 1)

Side Key 1 is the programmable key that can be assigned with long press function and short press function by your dealer. (See Glossary for definitions of short press and long press.)

***SK2** (Side Key 2)

Side Key 2 is the programmable key that can be assigned with long press function and short press function by your dealer. (See Glossary for definitions of short press and long press.)

*LED indicator

Status of LED indicator and alert tone see table below (See Functions and Settings for the detailed operations):

Power up in user mode	<p>When the radio is turned on, the power up alert tone is heard.</p> <p>When the current channel is a blank channel, the radio sounds Beep tone continuously.</p>
Low battery alert	LED flashes red, and a low-pitched tone sounds at intervals of 10 seconds.
Transmitting	<p>LED glows red when transmitting</p> <p>When TOT timer expires, the radio sounds Beep tone continuously.</p> <p>TOT pre-alert: a Beep is heard.</p> <p>Tx PTT ID: continuous Beep tone (programmed by your dealer, available to TC-610P only).</p> <p>Tx PTT ID Completion: short Beep tone (programmed by your dealer, available to TC-610P only).</p>
Receiving	LED glows green when carrier is present.
Scanning	Green LED flashes at every 1 second, while scanning

	<p>is in process.</p> <p>Scan Start Alert Tone (programmable by your dealer): a beep is heard.</p> <p>Scan Exit Alert Tone (programmable by your dealer): a beep is heard.</p> <p>Priority Channel Scan Alert Tone (programmable by your dealer): when scanning, if the current channel is the priority channel, the radio sounds a Beep.</p>
Power adjust	<p>A low-pitched tone is heard when transmit power is adjusted from high power to low power.</p> <p>A high-pitched tone is heard when transmit power is adjusted from low power to high power.</p>
VOX	<p>A high-pitched tone is heard when the VOX feature is activated.</p> <p>A low-pitched tone is heard when the VOX feature is disabled.</p>

***Channel Selector Knob**

Rotate the knob to select from channel 1 to 16.

*** Radio On-Off/Volume Control Knob**

Rotate the knob clockwise to turn the radio on, rotate the knob fully counter-clockwise until a click is heard to turn the radio off.

Turn the knob clockwise to increase the volume, or counter-clockwise to decrease the volume.

***Battery latch**

Used to remove the battery.

*** Accessory Jack**

The jack is used to connect speaker, microphone, external PTT, earpiece, programming cable and cloning cable.

Battery Information

Initial Use

New batteries are shipped uncharged from the factory. Charge a new battery for 5 hours before initial use. The maximum battery capacity and performance is achieved after three full charge/discharge cycles. If you notice the battery power runs low, please recharge the battery.

Applicable Battery Packs

To reduce the risk of injury, charge only the battery specified by the manufacturer. Other batteries may burst, causing bodily injury and damage.

Caution:

1. To avoid risk of personal injury, do not dispose of batteries in a fire!
2. Dispose of batteries according to local regulations (e.g. recycling). Do not dispose as household waste.
3. Never attempt to disassemble the battery.

Battery Tips

1. When charging your battery, keep it at a temperature among 5°C - 40°C. Temperature out of the limit may cause battery leakage or damage.
2. When charging a battery attached to a radio, turn the radio off to ensure a full charge.
3. Do not cut off the power supply or remove the battery when charging a battery.
4. Never charge a battery that is wet. Please dry it with soft cloth prior to charge.
5. The battery will eventually wear out. When the operating time (talk-time and standby time) is noticeably shorter than normal, it is time to buy a new battery.

To Prolong Battery Life

1. Battery performance will be greatly decreased at a temperature below 0°C. A spare battery is necessary in cold weather. The cold battery unable to work in this situation may work under room temperature, so keep it for later use.
2. The dust on the battery contact may cause the battery cannot work or charge. Please use clean dry cloth to wipe it before attaching the battery to the radio.

Battery Storage

1. Fully charge a battery before you store it for a long time, to avoid battery damage due to over-discharge.
2. Recharge a battery after several months' storage (Ni-MH & Ni-Cd batteries: 3 months; Li-Ion & Li-polymer batteries: 6 months), to avoid reducing battery capacity due to over-discharge.
3. Store your battery in a cool, dry place under room temperature, to reduce self-discharge.

Charging Operation

When the radio flashes red LED and sounds low-pitched tone at intervals of ten seconds, indicating the battery power is low, please charge the battery by the HYT approved charger. The charger's LED indicates the charging progress.

Status	Charger LED	Remarks
Standby (no-load)	Red LED flashes slowly (0.2s on/3s off)	Intelligent rapid-rate charger only
Battery is charging	Red LED solidly glows	
Battery is fully charged	Green LED solidly glows	
Error	Red LED flashes rapidly (0.2s on/0.2s off)	Intelligent rapid-rate charger only

Charging please refer to the following procedure:

(Take TC-610 as the sample)

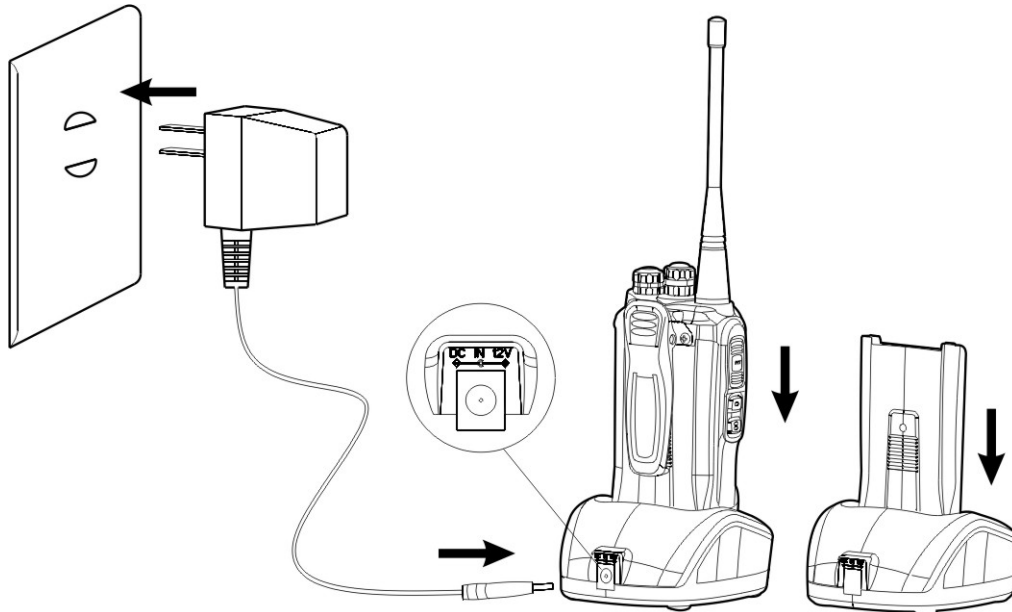

1. Plug the DC connector of the adapter into the DC socket on the back of the charger.
2. Place the radio with the battery attached, or the battery alone, in the charger.
3. Plug the AC connector of the adapter into the AC outlet socket.
4. Make sure the battery is in well contact with the charging terminals, the charging process initiates when the red LED lights.
5. The green LED lights about 3 hours later indicating the battery is fully charged. Then remove the radio with the battery attached or the battery alone from the charger.

Troubleshooting:

When troubleshooting, always observe the color of the LED.

No LED Indication?

1. Make sure that the power cord is plugged into an appropriate AC outlet.

Red LED flashes rapidly (0.2s on/0.2s off)?

1. Remove the battery from the charger, and:
 - a) Make sure that it is a HYT authorized battery. Other batteries may not charge.
 - b) Remove power from the battery charger, and clean the gold metal, charging contacts of the battery and charger, using a clean dry cloth.

2. The battery temperature may be above 45°C.
3. Defective battery. Please replace it with a new one.
4. Power up the charger and place the battery back into the charger pocket. If the LED indicator continues to flash red, replace the battery.

Note:

✚ When the battery charger detects the proper battery conditions, rapid charging begins automatically (steady red LED).

If the battery temperature is above 45°C, the charger will report the fault by flashing red LED rapidly (0.2s on/0.2s off), and will not charge until the battery temperature is below 45°C, with red LED solidly glows (Ni-MH battery only).

Antenna Information

- ✧ Stubby antennas are ideal for communication within limited range. Fine and long antennas optimizes communication coverage, ideal when the radio is worn on the belt because they are flexible and soft.
- ✧ Rainy days or forest locations may narrow your communication range, please prepare in advance to avoid potential inconvenience.

Assembly and Disassembly

(Note: Pictures listed below all take TC-610 as the sample)

Attaching the Battery

1. Hold the battery and make it close to the top of aluminum chassis. (See figure 1 below)
(Note: insert the tab on the top of battery into the top of battery slot).

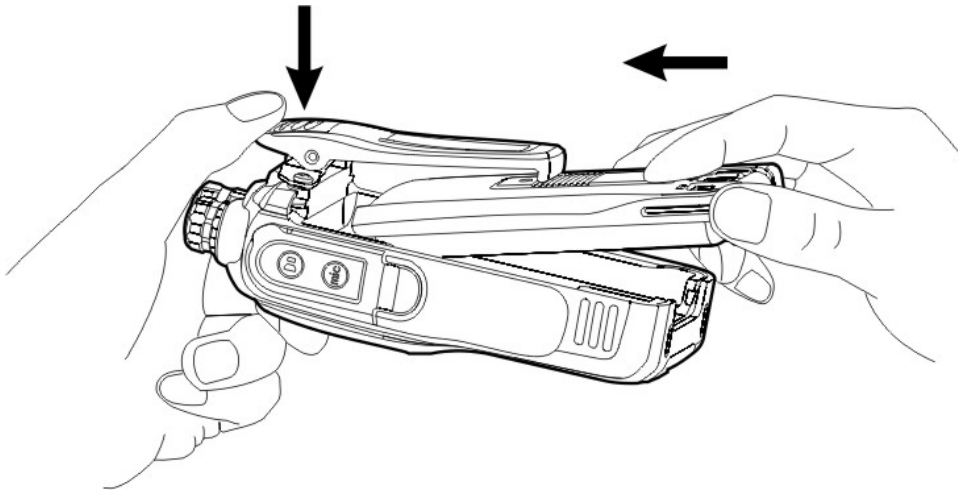

Figure 1

2. Lightly press the bottom of the battery until a click is heard. By then, the battery latch locks with the main unit and assembly is finished. (See figure 2 below)

Note: if the battery is not well locked, please remove the battery and attach it again.

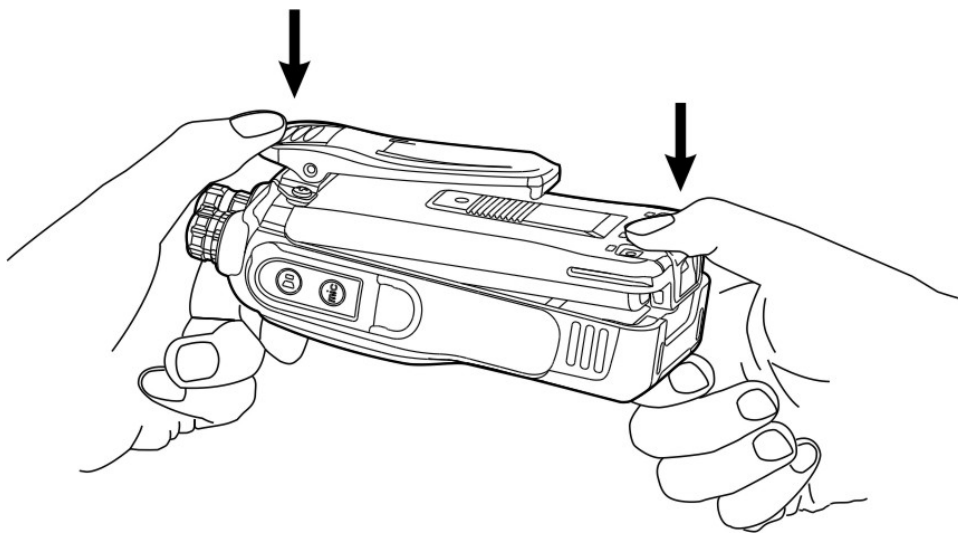

Figure 2

Removing the Battery

1. Please turn off the radio first. Then hold the top of radio main unit and press belt clip to make its tail turn up. Lift the battery latch in the direction of the arrow. (See figure 3 below)

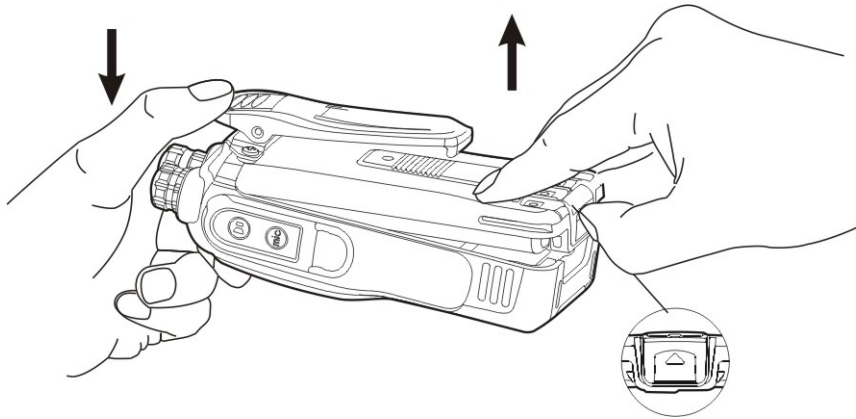

Figure 3

2. When the bottom of battery is lifted, release the battery latch and take out from the battery slot. (see figure 4 below)

(Note: when battery is tilted, the angle between battery and main unit can not be **too large so that serious abrasion of the tab in the top of battery is caused.**)

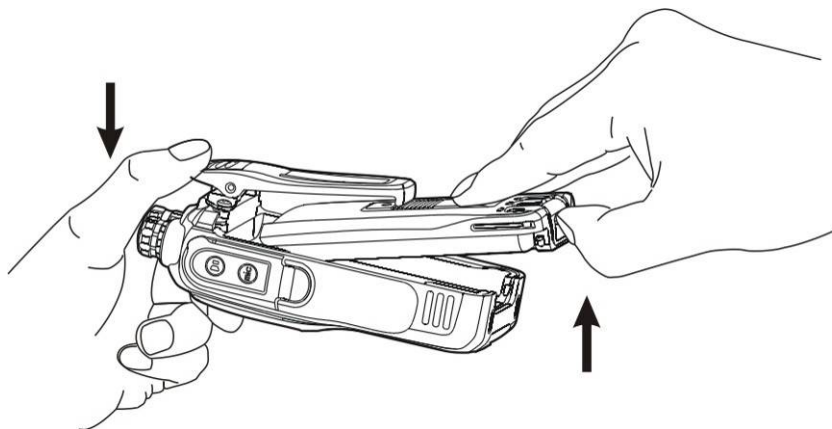
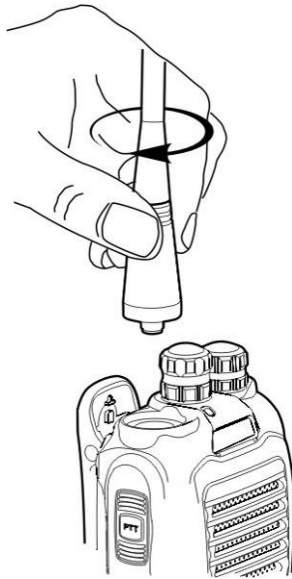

Figure 4

Attaching the Antenna

1. Insert the antenna to the big screw thread hole on the top of main unit.
2. Turn the antenna clockwise until it is screwed down, shown as figure 5.

**Figure 5**

Removing the Antenna

When disassembling antenna, turn the antenna counter-clockwise until it is loosen and screwed out, shown as figure 6.

**Figure 6**

Attaching the Belt Clip

Loose the screw of belt clip from the main unit, fasten the belt clip to the main unit (make sure the screw holes of belt clip and of aluminum chassis are aligned), clockwise screw down the belt clip. (See figure 7 below)

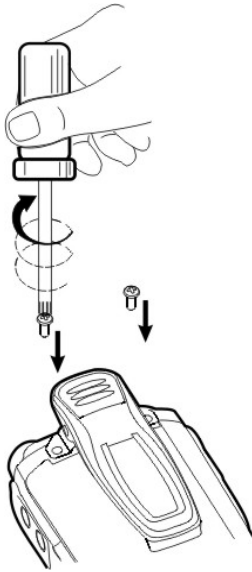
**Figure 7****Removing the Belt Clip**

Turn the screwdriver counter-clockwise to loosen the screw. Please refer to the operations for attaching the belt clip. (See figure 8 below)

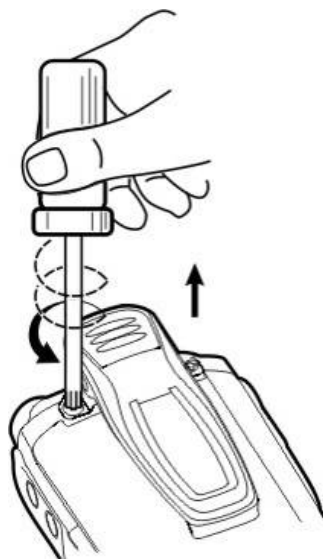
**Figure 8****Attaching the Earpiece/Microphone (TC-610)**

1. Open (not remove) the accessory cover, shown as figure 9.

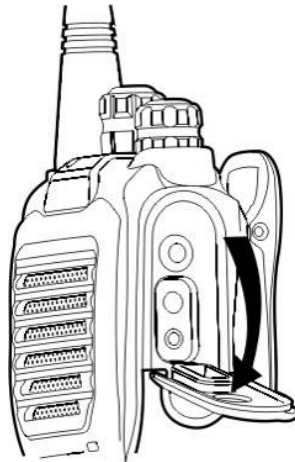

Figure 9

2. Plug the audio accessory firmly into the accessory jack, then secure the screw, shown as figure 10.

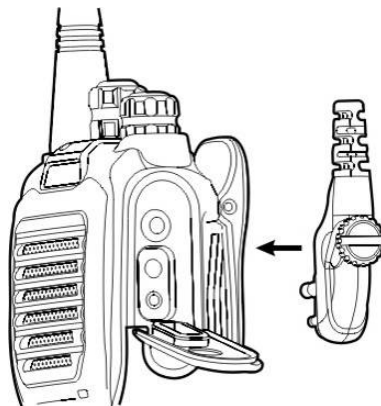

Figure 10

Attaching the Earpiece/Microphone (TC-610P)

1. Insert the tab at the bottom of the earphone/microphone into the slot on the radio.
2. Align the screw at the top of the earphone/microphone with the threaded hole on the radio.
3. Rotate the screw clockwise to fasten. (See Figure 11 below)

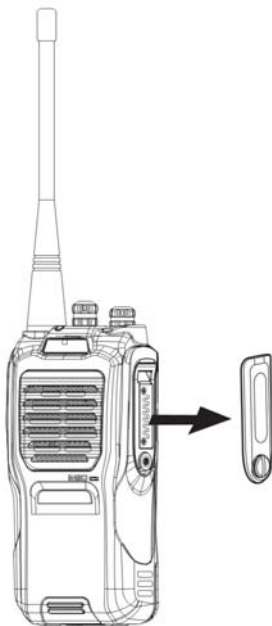

Figure 11

2. Plug the audio accessory firmly into the accessory jack, and then secure the screw, shown as figure 12.

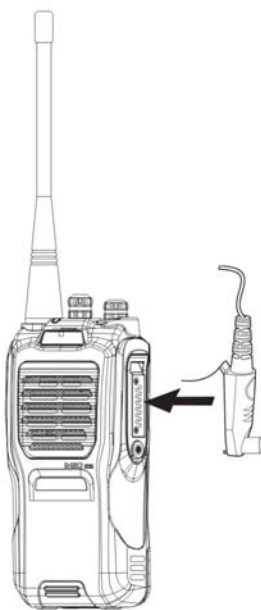

Figure 12

Removing the Earpiece/Microphone

Loosen the screw and then remove the audio accessories.

Note: Using the radio with audio accessory may affect the waterproof performance of the radio.

General Radio Operations

(Note: Pictures listed below all take TC-610 as the sample)

Note: See Glossary for definitions of relevant words.

Turn the Radio On/Off

Turn the radio on-off /volume control knob clockwise to turn on the radio, then radio sounds an alert tone. Turn the radio on-off /volume control knob counter-clockwise to turn off the radio.

(See figure 13 below)

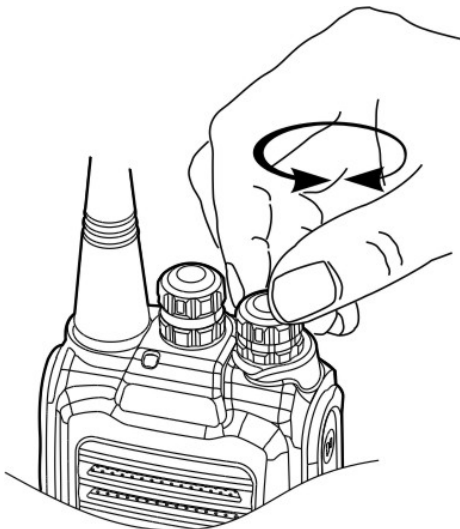

Figure 13

Adjust the Volume

Press the programmable key set as Squelch Off / Squelch Off Momentary to listen the background noise, then turn the volume control knob clockwise/counter-clockwise to increase/decrease the volume. See Glossary for definition of Squelch. (See figure 14 below)



Figure 14

Select a Channel

Turn the channel selector knob to select a channel. (See figure 15 below)

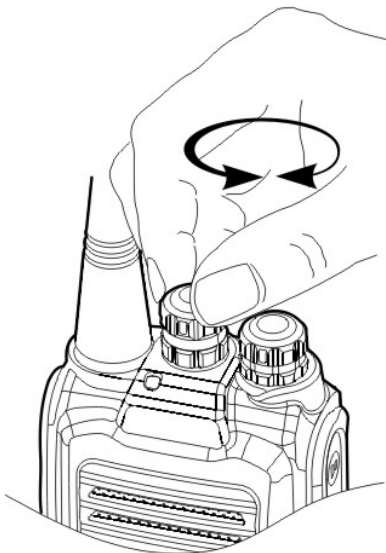

Figure 15

Transmitting

To transmit, press and hold down **PTT** key and talk to microphone to speak. Ensure the radio is 2.5 to 5 centimeters away from your lips.

Receiving

To receive signal, release the **PTT** key.

Talk Range

Flat ground with no obstructions	Up to 10 kilometers
Residential area (close to buildings)	Up to 5 kilometers
Inside multi-level buildings	Up to 20 floors

Programmable Auxiliary Functions

Your dealer may program the **TK**, **SK1**, **SK2** (long or short press) keys with one of the following auxiliary functions respectively. See Functions and Settings for the detailed description.

- None
- Power Adjust
- Battery Power Indicator
- Squelch Off (See Glossary for definitions of Steady and Squelch Off.)
- Squelch Off Momentary
- Monitor
- Monitor Momentary (See Glossary for definitions of Momentary and Monitor)
- Scan (See Glossary for definition of Scan.)
- VOX

Functions and Settings

The following functions are programmable by your dealer.

CTCSS/CDCSS

Set up talkgroups with unique CDCSS/CTCSS to prevent unwanted conversations on the same frequency. See Glossary for definitions of CTCSS and CDCSS.

If CTCSS/CDCSS is set on the current channel, CTCSS/CDCSS match is required for the radio to unmute to an incoming signal. If CTCSS/CDCSS is not set, the radio can receive calls from all users operating on the same frequency. Your dealer may set CTCSS/CDCSS for some

channels.

This feature does not mean that your conversation will not be heard by others. Radios that set with the same CTCSS/CDCSS, or no CTCSS/CDCSS, can receive from you.

Battery Save

This feature can be enabled by your dealer. The Battery Save feature is automatically activated once no activity on the channel and no operation performed (no key press and no knob selection), for extended operation time.

Pressing any key or receiving a signal will restore the radio to normal operation and exit from Battery Save.

See Glossary for the definition of Battery Save.

Power Adjust

A press of the programmed **Power Adjust** key switches the transmit power level between high and low power.

Time-out Timer (TOT)

Limits the amount of time the radio user can continuously transmit on a channel. If the user holds down the **PTT** longer than the preprogrammed limit, the radio automatically stops transmitting, and generates a warning tone until the **PTT** is released.

Your dealer may program the alert tone that sounds before the TOT timer nearly expires.

See Glossary for the definition of Time-out Timer.

Battery Strength Indicator

The TC-610/610P allows you to simply press one button to illuminate the LED batter gauge, which emits different indications representing battery strength levels until the key is released.

Battery Strength	LED Indication
70% - 100%	Green
50% - 70%	Orange
30% - 50%	Red
10% - 30%	No indication is shown when programmable key is pressed; LED flashes red while radio is operating. While the radio standby, LED flashes red and a low-pitched tone sounds at intervals of a preset time (defaulted as 10s). The interval can be set by programming software.
Less than 10%	No indication is shown when programmable key is pressed; at the time, radio can only receive or standby (Tx is disabled). While the radio standby, LED flashes red and a low-pitched tone sounds at intervals of a preset time (defaulted as 10s). The interval can be set by programming software. If PTT key is held down, an alert tone indicating low-voltage Tx inhibit would sound.

Monitor / Squelch Off

- **Squelch Off**

Causes the radio to forcibly unmute speaker to here activities on the current channel, whatever the receive condition is. The radio speaker outputs audio when audio signal is present, or background noise will be heard if no audio signal is detected.

Press the function key to enter the Squelch Off mode, and press it again to exit.

- **Squelch Off Momentary**

Causes the radio to forcibly unmute speaker to here activities on the current channel, whatever the receive condition is. The radio speaker outputs audio when audio signal is present, or background noise will be heard if no audio signal is detected.

Holds down the function key to enter the **Squelch Off Momentary** mode, and release it to exit.

- **Monitor**

Carrier condition must be satisfied for the radio to unmute to an incoming call, regardless of CTCSS/CDCSS condition.

Press the function key to enter Monitor mode, and press it again to exit.

- **Monitor Momentary**

Carrier condition must be satisfied for the radio to unmute to an incoming call, regardless of CTCSS/CDCSS condition.

Holds down the function key to enter Monitor Momentary mode, and release it to exit.

Scan

Press the programmed **Scan** key to initiate scanning ascending through the channel numbers in scan list. Green LED flashes during the scan process, and solidly glows when activity is detected on a channel and signalling condition is satisfied. Press the key again to exit scanning.

When scanning is active, the radio continuously scans for activity on scan list members. Once activity is detected on a channel, scanning pauses on the active channel for you to receive activity. Your dealer can choose channels that you wish to scan and list them in a scan list.

No Priority Channel

Assuming a scan list with 6 channels, if all the channels are non-prioritized, the normal scan operation would check for activity in the following sequence, as figure 16 has shown.

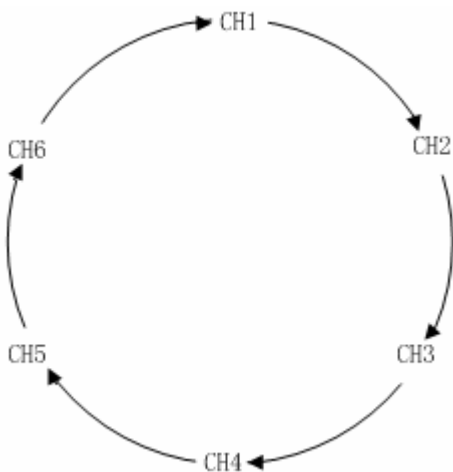

Figure 16

Priority Channel Scan

If you prioritize Channel 2 as Priority 1, the scan operation would change as figure 17 shown below.

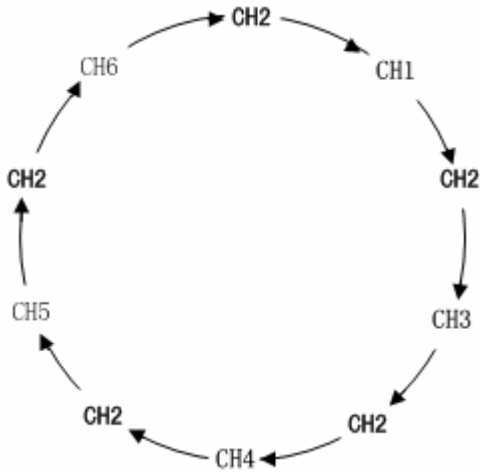

Figure 17

Scan On/Off

You can enter scan mode through the following two methods:

1. Key operation

Press the programmed **Scan** key to enter scan mode, provided that there're no less than 2 members in the scan list.

2. Auto

When Auto Scan is enabled for a channel, the radio shall automatically enter scan mode when it is switched to the channel.

You can exit scan mode through the following three methods:

1. Key operation

Press the programmed **Scan** key to exit scan mode.

2. Auto

The radio automatically exits from scan mode when it is switched to another channel.

3. Turn the radio off.

- **Talk Back**

You can respond to any calls received during the scan process by pressing the **PTT**.

- **Priority Channel Scan**

Enable you to constantly monitor & keep an update on the activities on the most commonly used

channel so that messages will not be missed. Check with your dealer for details.

When scanning remains on a non-priority channel, the radio continues to monitor activities on the priority channel, and jumps to the priority channel if activity is detected.

Busy Channel Lockout (BCL)

Avoid interference with the users using the same channel by preventing transmission if another talk group is already on the air. The radio will generate a continuous tone upon **PTT** press if a transmission is not allowed. Release the **PTT** to cancel the tone.

See Glossary for definition of BCL.

Low Battery Alert

For extra convenience, LED flashes red and a low-pitched tone sounds at every ten seconds to alert users to recharge the battery should the battery level run low.

Voice Operated Transmit (VOX)

You can transmit hands free with the use of optional accessories. The radio will automatically begin transmitting when you speak, and terminate transmitting when you stop talking. See Glossary for definition of VOX.

Press the programmed **VOX** key to activate or exit the **VOX** feature, with alert tone sounds accordingly.

Your dealer can enable/disable the VOX feature, and set the VOX sensitivity. When VOX feature is enabled, the user can transmit hands free with VOX accessories:

1. Press the programmed **VOX** key to activate the VOX feature.
2. Select the **PTT/VOX** switch on the earpiece to **VOX**.
3. Plug the earpiece into the accessory jack.
4. Speaker into the earpiece microphone and your voice will be transmitted.

When transmitting with VOX accessories, you may here your own voice from the VOX earpiece slightly. Press the **PTT** of your radio to disable the VOX feature. Turn the radio off on again, or plug the earpiece into the accessory jack again to restore the VOX feature.

Note: No matter whether the VOX feature is enabled, if you select the **PTT/VOX** switch on the earpiece to **PTT**, you are able to transmit by press of the external **PTT**, and you are not allowed to push the switch from **PTT** to **VOX**, this action shall cause the radio to continuously transmit. When continuous transmission occurs, push the **PTT/VOX** switch from **VOX** to **PTT**, or turn on the radio again to restore the radio to operation use. (See figure 18 below)

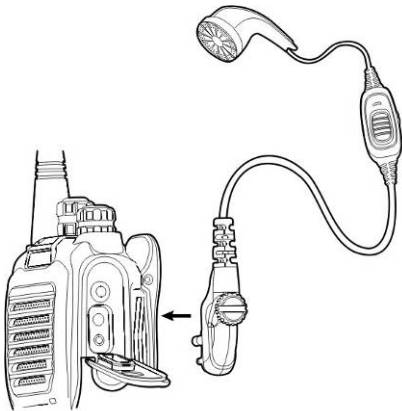

Figure 18

Note: to order accessories, please contact your dealer.

ATIS

When holding down **PTT** key, radio with ATIS function (Auto Identification Setting) transmits a 12 digits ID code according to private code regulation and modulation method. By the function, manager monitors the devices on the go in any time and avoids valid use of them.

Note: ATIS enable check and 12 digits ID identification code can be programmed by your dealer.

HDC1200 PTT ID Encode (Available to TC-610P only)

When **PTT** key is held down or released, calling party transmits an ID code; then the called party or manager gets the calling party ID through identification of ID code being received. By the function, improper use of device, system business recording as well as quick response for emergency all can easily be realized.

Note: Options for PTT ID transmission and ID code can be programmed by your dealer.

DOS (Data Operated Squelch)

The function is to filter unnecessary noise and secure enough quiet when receiving ATIS and

HDC1200 PTT ID data. DOS time can be programmed by your dealer.

Note: DOS enable check and DOS time can be programmed by your dealer.

2-Tone Decode (Available to TC-610P only)

The function is to receive 2-tone signal that transmitted by radio with 2-tone encode and to respond the function according to the preset configuration.

Note: Parameter setting of 2-tone decode can be programmed by your dealer.

Troubleshooting

Symptom	Solution
Cannot power on the radio.	a. The battery is run out. Please recharge the battery or replace it with a fresh one. b. The battery is not properly installed. Please remove and reinstall the battery.
The operation time will not increase even though the battery is properly charged.	a. The battery life cycle is over, please replace with a new one. b. The battery is not fully charged. Make sure that the battery is removed after LED indicator has indicated green.
Cannot talk to or hear group members.	a. Confirm radios have the same channel, and CTCSS/CDCSS settings. b. Make sure you are within their communication range.
Hear non-group members	a. Please change your CTCSS/CDCSS settings, and so as your group members.
No voice or low voice while transmitting	a. Whether the volume switch knob is switched to a proper position. b. Send the radio to your dealer for microphone detection.
Noise always on	a. Group members are too far away to receive their call. Please go within the communication range and re-power on the radio to try.

Care and Cleaning





- Do not handle the radio by its antenna or external microphone directly.
- Do not place the radio in a dusty or dirty environment.
- Clean the radio with a lint-free cloth to remove dirt or grease, to avoid poor contact due to excessive dust.
- Clean the radio using a lint-free cloth moistened with clean water and a mild dishwashing liquid.
- Avoid subjecting the radio to corrosives, solvents or spirits.

















Optional Accessory













Optional Accessories





			
<p>Antenna</p>	<p>Ni-MH Battery (1300mAh) BH1303</p>	<p>Li-Ion Battery (2000mAh) BL2001</p>	<p>MCU Multi-unit Rapid-rate Charger (for Li-ion/Ni-MH Batteries) MCA02</p>
			
<p>Six-unit Switching Power PS7001</p>	<p>Vehicle Adapter CHV09</p>	<p>Universal Nylon Chest Pack (Black) LCBN13</p>	<p>Leather Carrying Case (non-swivel) LCBN56</p>

TC-610P Optional Audio Accessories

			
<p>Earbud with in-Line PTT ESN05</p>	<p>Earbud with on-MIC PTT ESN06</p>	<p>D-earset with Boom Microphone EHN08</p>	<p>D-earset with in-line Microphone EHN07</p>

			
<p>Light-weight, Behind-the-head Earpiece ECN06</p>	<p>Light-weight, Single-muff Headset ECN07</p>	<p>Earpiece with on-MIC PTT & Transparent Acoustic Tube EAN04</p>	<p>2-wire Surveillance Earpiece with Transparent Acoustic Tube (black) EAN07</p>
			
<p>3-Wire Surveillance Earpiece with Transparent Acoustic Tube (black/beige) EAN02/EAN06</p>	<p>2-Wire Earpiece with Wireless Receiver and Neck Loop EWN03</p>	<p>Heavy Weight, Noise-Canceling Headset ECN08</p>	<p>Behind-the-Head, Noise-Canceling Headset ECN09</p>
			
<p>Light Weight, Throat-Vibrating Earpiece ELN02</p>	<p>Ear Canal Bone Induction Earpiece EBN01</p>	<p>Noise-Canceling Remote Speaker Microphone (IP56) SM13N5</p>	<p>Noise-Cancelling Remote Speaker Microphone (Antenna Applicable) SM13N4</p>
			
<p>Remote Speaker Microphone SM08N1</p>	<p>Receive-only Earbud (for use with remote speaker microphone) ESS07</p>	<p>Receive-only Earpiece with Transparent Acoustic Tube (for use with remote speaker microphone) ESS08</p>	<p>Programming Cable (COM port) PC18</p>

			
<p>Programming Cable (USB port) PC25</p>			
<p>TC-610 Optional Audio Accessories</p>			
			
<p>Earbud with in-line PTT & VOX ESM13</p>	<p>Earbud with on-MIC PTT & VOX ESM12</p>	<p>Earbud with in-line PTT & VOX ESM11</p>	<p>D-earset with in-Line MIC & VOX EHM15</p>
			
<p>Earset with in-line Microphone & VOX EHM18</p>	<p>D-earset with in-line Microphone & VOX EHM15</p>	<p>D-earset with Boom Microphone & VOX EHM16</p>	<p>Light Weight, Behind-the-Head Earpiece with in-Line PTT & VOX ECM11</p>
			
<p>Light Weight, Single-Muff Headset with in-Line PTT & VOX ECM12</p>	<p>Earpiece with on-MIC PTT & VOX & Transparent Acoustic Tube EAM12</p>	<p>2-Wire Surveillance Earpiece with VOX & Transparent Acoustic Tube (black) EAM13</p>	<p>3-Wire Surveillance Earpiece with Transparent Acoustic Tube (black/beige) EAM16 / EAM15</p>

			
<p>Neck 2-wire Earpiece with Wireless Earphone and Neck Loop(Beige) EWM03</p>	<p>Ear Canal Bone Induction Earpiece EBM01</p>	<p>Light Weight, Throat-Vibrating Earpiece ELM01</p>	<p>Noise-Canceling Headset ECM13</p>
			
<p>Behind-the-Head, Noise-Canceling Headset ECM14</p>	<p>Remote Speaker Microphone SM08M3</p>	<p>Noise-Canceling Remote Speaker Microphone (IP56) SM13M1</p>	<p>Noise-Cancelling Remote Speaker Microphone (Antenna Applicable) SM13M2</p>
			
<p>Receive-only Earbud (for use with remote speaker microphone) ESS07</p>	<p>Receive-only Earpiece with Transparent Acoustic Tube (for use with remote speaker microphone) ESS08</p>	<p>Programming Cable (COM port) PC19</p>	<p>Programming Cable (USB port) PC26</p>

Channel Frequency Table

Model: _____

Serial No.: _____

Channel	Tx Frequency (MHz)	Tx CTCSS /CDCSS	Rx Frequency (MHz)	Rx CTCSS/CDCSS
1				
2				
3				
4				
5				
6				
7				
8				
9				
10				
11				
12				
13				
14				
15				
16				

CTCSS Table 38

No.	Frequency (Hz)	No.	Frequency (Hz)
1	67.0	20	131.8
2	71.9	21	136.5
3	74.4	22	141.3
4	77.0	23	146.2
5	79.7	24	151.4
6	82.5	25	156.7
7	85.4	26	162.2

8	88.5	27	167.9
9	91.5	28	173.8
10	94.8	29	179.9
11	97.4	30	186.2
12	100.0	31	192.8
13	103.5	32	203.5
14	107.2	33	210.7
15	110.9	34	218.1
16	114.8	35	225.7
17	118.8	36	233.6
18	123.0	37	241.8
19	127.3	38	250.3

CDCSS Table (83)

No.	CDCSS	No.	CDCSS
39	023	82	331
40	025	83	343
41	026	84	346
42	031	85	351
43	032	86	364
44	043	87	365
45	047	88	371
46	051	89	411
47	054	90	412
48	065	91	413
49	071	92	423
50	072	93	431
51	073	94	432
52	074	95	445
53	114	96	464
54	115	97	465
55	116	98	466

56	125	99	503
57	131	100	506
58	132	101	516
59	134	102	532
60	143	103	546
61	152	104	565
62	155	105	606
63	156	106	612
64	162	107	624
65	165	108	627
66	172	109	631
67	174	110	632
68	205	111	654
69	223	112	662
70	226	113	664
71	243	114	703
72	244	115	712
73	245	116	723
74	251	117	731
75	261	118	732
76	263	119	734
77	265	120	743
78	271	121	754
79	306		
80	311		
81	315		

Glossary

Name	Description
Short Press	Key press shorter than 1.5 seconds.
Long Press	Key press longer than 1.5 seconds.
Standby Status	In normal mode, no key operation is made on the radio and the radio is in receiving status.
CTCSS/CDCSS	The setting of CTCSS/CDCSS code in transmitting party must match that in the receiving party, for the receiver to unmute its speaker to output audio.
Battery Save	The function is to save the battery power and prolong the operation time. Once no activity on the channel and no operation performed, the radio shall be on and off alternately.
Time-out Timer (TOT)	The time-out timer feature stops someone from talking too long and tying up the channel.
Squelch	The purpose of squelch is to mute audio output from the speaker when no signals are present. Open the squelch to unmute radio speaker.
Squelch Off	Always unmute speaker to receive audio as well as background noise.
Monitor	Carrier condition must be satisfied for the radio to unmute to an incoming call, regardless of CTCSS/CDCSS condition.
Momentary	Holds down the function key to activate the status, and release it to exit.
Scan	The scan feature enables the radio to continuously scan each channel for activity.
Busy Channel Lockout	Avoid interference with the users using the same

	channel by preventing transmission if another talk group is already on the air.
VOX	The radio will automatically begin transmitting when you speak.

HYT endeavors to achieve the accuracy and completeness of this manual, but no warranty of accuracy or reliability is given. All the above specifications and design are subject to change without notice due to continuous development.

No part of this manual may be copied, reproduced, translated, stored in a retrieval system, distributed, or transmitted in any form or by any means, electronic or mechanical, for any purpose without the express written permission of HYT.